

## Transmission Line Transformer(4.5-3000MHz)

### Features

- Surface mount
- Impedance ratio: 1:1
- Available on tape and reel
- RoHS compliant and Pb free

### Description

#### SCOPE

- MCTLT1-1-037 is a 1:1 Transmission Line transformer in a SMT package.

#### APPLICATIONS

- Ideally suited for CATV and Satellite STB/Subscriber applications.

### Functional Schematic

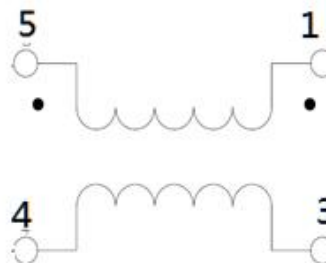

### Pin Configuration

Pin #	Function	Pin #	Function
1	Secondary Dot	4	Primary
2	Not Connected	5	Primary Dot
3	Secondary		

### Electrical Specifications @ 25°C

Parameters (P#: ENA PORT)	frequency band	Min.	Typ.	Max.	Unit
Port Impedance, Z <sub>0</sub> (P1 / P2 / P3)			75/37.5/37.5		Ohm
Insertion Loss 1 (Pin 4 to Pin 3)	4.5-1000MHz		0.6	1.0	dB
	1000-2000MHz		1.7	2.0	dB
	2000-2500MHz		2.3	5.0	dB
	2500-3000MHz		3.2	6.5	dB
Insertion Loss 2 (Pin 4 to Pin 1)	4.5-1000MHz		0.8	1.0	dB
	1000-2000MHz		0.9	2.0	dB
	2000-2500MHz		1.9	6.0	dB
	2500-3000MHz		2.6	8.4	dB
Input Return Loss (Pin 4)	4.5-1000MHz	15.0	24		dB
Amplitude Balance	4.5-20MHz		0.9	±1.2	dB
	20-1000MHz		0.5	±1.0	dB
Phase Balance (Nominal 180°)	4.5-1000MHz		3	±20	°

## Transmission Line Transformer(4.5-3000MHz)

### Application & Test Circuit

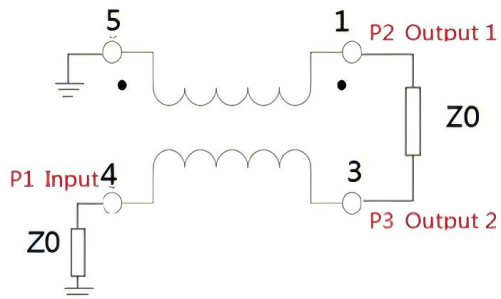

### Absolute Maximum Ratings

Parameter	Value
Input Power	250mW MAX
DC Current	30mA MAX
Operating Temperature Range	-40 to 85°C

## Transmission Line Transformer(4.5-3000MHz)

### Test Curve

*Insertion Loss:Pin 4 to 3*

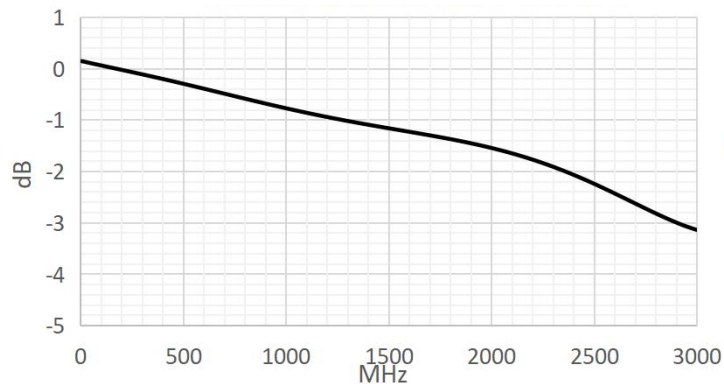

*Insertion Loss:Pin 4 to 3*

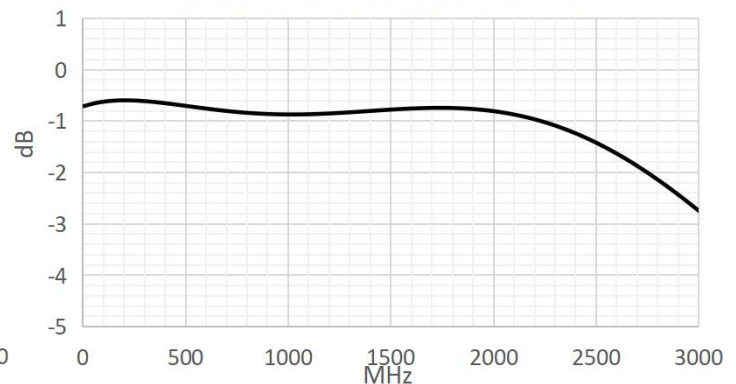

*Amplitude Balance*

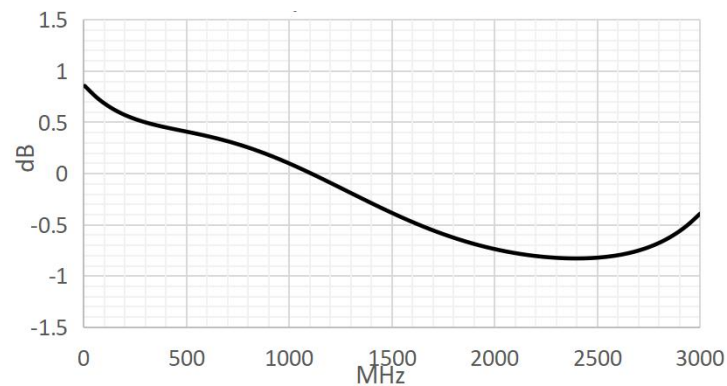

*Phase Balance*

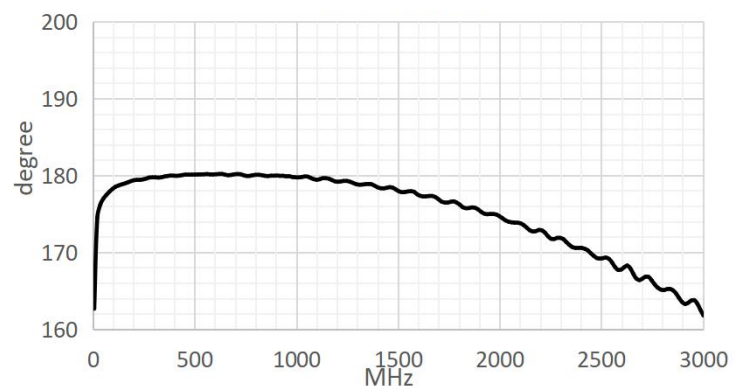

*Input Return Loss: Pin 4*

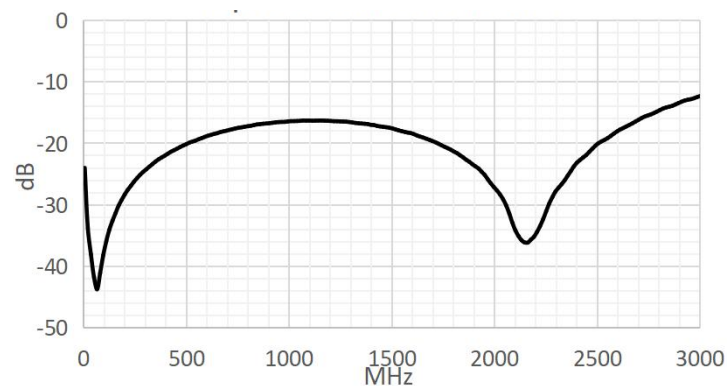

## Transmission Line Transformer(4.5-3000MHz)

### Dimensions

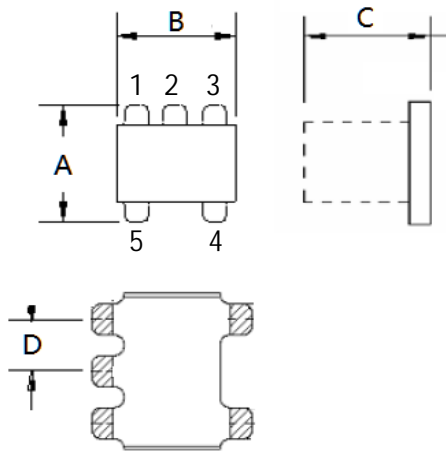

### Land Pattern

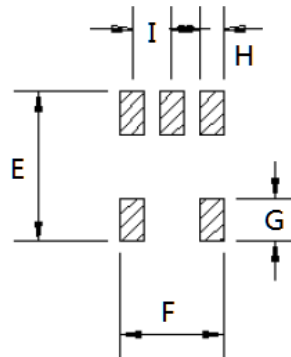

A	B	C
3.81	3.81	2.90
D		
1.27		

E	F	G
4.83	3.30	1.40
H	J	
0.76	1.27	

Unless otherwise stated dimensions are in mm

Tolerance: .xx ± 0.25, .xxx ± 0.05

## Transmission Line Transformer(4.5-3000MHz)

### Packing

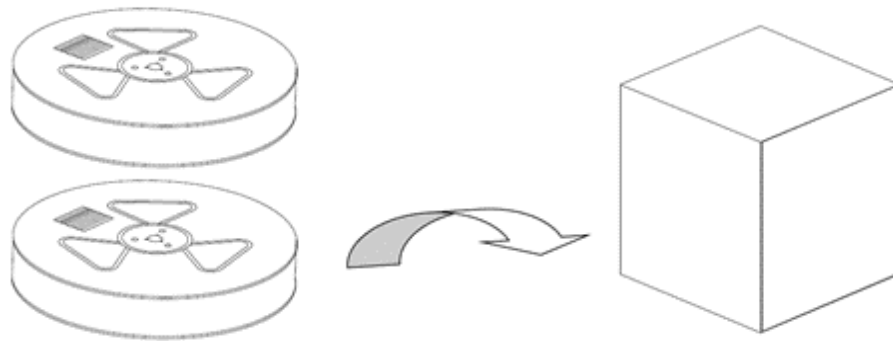
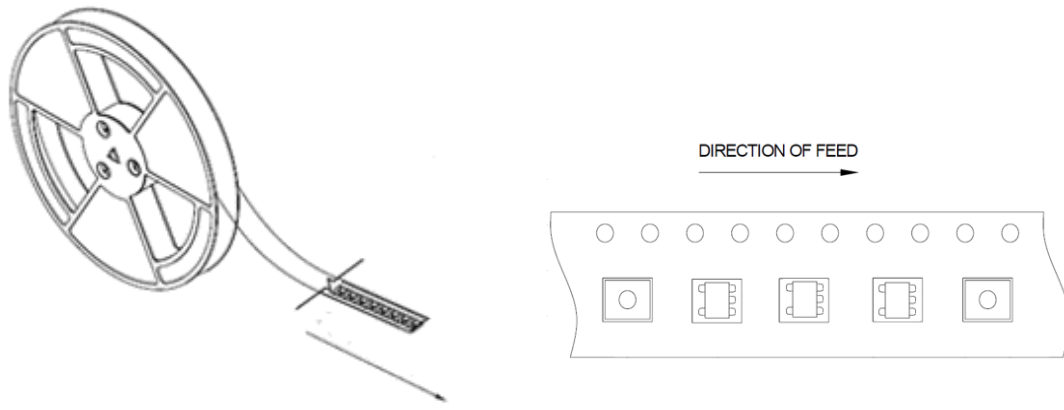

Ten Reel

Export Carton

Quantity per reel: 2000 pcs

Quantity per export carton: 20000 pcs